

Item No 02:-

20/02175/FUL

**Northcote
Cold Aston
Cheltenham
Gloucestershire
GL54 3BW**

Item No 02:-

Erection of a two-storey rear extension, single-storey side and rear extensions, new dormer windows and alterations to dwellinghouse and erection of detached annexe at Northcote Cold Aston Cheltenham Gloucestershire GL54 3BW

Full Application 20/02175/FUL	
Applicant:	Mr & Mrs T Hayman-Joyce
Agent:	Eastabrook Architects
Case Officer:	Amy Hill
Ward Member(s):	Councillor Richard Keeling
Committee Date:	14th October 2020
RECOMMENDATION:	REFUSAL

Main Issues:

- (a) Design and Impact on Heritage Assets
- (b) Impact on Cotswolds Area of Outstanding Natural Beauty (AONB)
- (c) Impact on Residential Amenity

Reasons for Referral:

Councillor Keeling has called the application to the Planning and Licensing Committee for the following reason:

"I am in disagreement with your recommendation to refuse and would like this application to be referred for consideration by the Planning and Licensing Committee. In view of the multiple alterations to the original pair of cottages over many years, the location outside Cold Aston Conservation Area, and the subjective nature of the property's classification as a Non Designated Heritage Asset I would like members to consider the recommendation to refuse the application (Policy EN 12)."

1. Site Description:

The site consists of a designed pair of 19th Century estate cottages, characterised by their small scale and simple design. Although altered at the rear by two almost symmetrical rear extensions, the history of the building is clearly evident from its visual appearance, and retains a clear sense of completeness, with limited alterations to the road facing front. The asymmetric garden has little impact on legibility of the history of the site. Given the above the dwelling is considered to be a Non-Designated Heritage Asset (NDHA) due to its architectural interest, historic interest, age and integrity. Although the historic two-storey extension was a significant increase in built form, the character of the two cottages as small scale simple dwellings is retained.

It is located just outside the Cold Aston Conservation Area and within the Cotswolds Area of Outstanding Natural Beauty (AONB). The house is set within a rural location and the topography is relatively flat. The site and the surroundings are open and flat with little vegetation cover to the north. Directly to the South is a current commercial garage with permission to be converted to a domestic dwelling.

Bangup Lane runs north to south to the front of the site, linking Cold Aston to Turkdean (approximately 2.6km directly), along which runs a Public Right of Way (PROW), the Cold Aston Restricted Byway 12. To the north of the site (approximately 155m) is the road leading from Cold Aston to Notgrove, along which runs the Gloucestershire Way (a promoted Long Distance Footpath).

2. Relevant Planning History:

Northcote :

CD.5934: Two storey extension at rear of dwelling to enlarge kitchen and hall on ground floor and bathroom and bedroom over. Permitted 1978.

17/00717/FUL: Detached garage and 1.1m Cotswold stone wall. Permitted 2017.

18/03519/FUL: Change of use of land to residential, two storey extensions, single storey link and alterations to dwellinghouse. Refused December 2018.

19/04706/FUL: Erection of a two-storey rear extension, single-storey side extension and alterations to dwellinghouse and erection of detached annexe. Permitted February 2020.

The Villas Workshop:

18/03684/FUL: Conversion of workshop to form one dwelling and erection of garage and garden store. Permitted November 2018.

3. Planning Policies:

TNPPF The National Planning Policy Framework

CDCLP CDC LOCAL PLAN 2011-2031

EN1 Built, Natural & Historic Environment

EN2 Design of Built & Natural Environment

EN4 The Wider Natural & Historic Landscape

EN5 Cotswolds AONB

EN10 HE: Designated Heritage Assets

EN11 HE: DHA - Conservation Areas

EN12 HE: Non-designated Heritage Assets

4. Observations of Consultees:

Conservation Officer: Views incorporated within the Officer's report

5. View of Town/Parish Council:

Not received at time of writing.

6. Other Representations:

1 Letter of Objection received:

- Use of black corrugated metal on annexe inappropriate, timber cladding considered more appropriate.
- Objection to the building being spot listed
- Extension considered acceptable

7. Applicant's Supporting Information:

Proposed Plans
Design and Access Statement
Heritage Report

8. Officer's Assessment:

Main Issues:

Section 38(6) of the Planning and Compulsory Purchase Act 2004 states that 'If regard is to be had to the development plan for the purpose of any determination to be made under the planning Acts the determination must be made in accordance with the plan unless material considerations indicate otherwise.'

The starting point for the determination of this application is therefore the current development plan for the District which is the adopted Cotswold District Local Plan 2011 - 2031.

The policies and guidance within the revised National Planning Policy Framework (NPPF) are also a material planning consideration.

The proposal is for an extension to the dwelling and the erection of an outbuilding. The proposed ancillary outbuilding is the same as that previously permitted by application 19/04706/FUL. It would measure approximately 5m by 9m, with an eaves and ridge height of 2.7m and 5.3m respectively, and would be clad in black corrugated sheeting.

The proposed extension includes a two-storey rear section measuring approximately 5.1m deep, 7.9m wide, with a ridge height of 7m (0.8m lower than the ridge of the existing dwellinghouse to which it would be attached). It has a double gable appearance. The extension would be constructed of Cotswold stone, a concrete tile roof, with painted timber windows. This main two-storey section currently proposed has the same dimensions and material palette as the extension previously permitted under application 19/04706/FUL; however, the current proposal includes an additional dormer window and altered single-storey section.

The single-storey section of the extension currently proposed comprises a flat-roofed timber clad addition to the sides and rear of the main two-storey stone extension. This section would result in a ground floor width of approximately 12.6m, in comparison to the existing width of the dwellinghouse of approximately 11m. It would extend approximately 7.2m beyond the rear wall of the existing dwellinghouse, of which 2m would be the ground floor section.

(a) Design and Impact on Heritage Assets

Local Plan Policy EN1 seeks, where appropriate, to promote the protection, conservation and enhancement of the historic and natural environment. Local Plan Policy EN2 states that 'Development will be permitted which accords with the Cotswold Design Code. Proposals should be of design quality that respects the character and distinctive appearance of the locality.'

Policy EN10 and EN11 of the Cotswold District Local Plan relate to designated heritage assets including their setting. This relates to the proposal in so far as the site is next to the Cold Aston Conservation Area; however, it is considered that given the scale of the proposal

and part of the Conservation Area it is next to, that the proposed development would not harm its setting.

Policy EN12 of the Cotswold District Local Plan is also considered of relevance. This states that the assessment of whether a site, feature or structure is considered to be a NDHA, will be guided by a set criteria which is included within the Local Plan. With regards to buildings and structures, this criteria includes such factors as architectural interest, historic interest, age, rarity, aesthetic merits, selectivity (representativeness), integrity (sense of completeness) landmark status, group value and historic association.

Policy EN12 also states that development affecting a NDHA will be permitted where it is designed sympathetically having regard to the significance of the asset, its features, character and setting. It continues, stating that where possible, development will seek to enhance the character of the non-designated heritage asset.

Section 12 of the NPPF seeks to achieve well-designed places. Section 16 of the NPPF states that historical 'assets are an irreplaceable resource, and should be conserved in a manner appropriate to their significance, so that they can be enjoyed for their contribution to the quality of life of existing and future generations'. Paragraph 192 states that local planning authorities should take account of the desirability of sustaining and enhancing the significance of heritage assets and putting them to viable uses consistent with their conservation. Paragraph 193 states that when considering the impact of a proposed development on the significance of a designated heritage asset, great weight should be given to the asset's conservation. Paragraph 194 states that any harm to, or loss of, the significance of a designated heritage asset (from its alteration or destruction, or from development within its setting), should require clear and convincing justification. Paragraph 196 states that where a development proposal will lead to less than substantial harm to the significance of a designated heritage asset, this harm should be weighed against the public benefits of the proposal including, where appropriate, securing its optimum viable use. Paragraph 197 of the NPPF states that the effect of an application on the significance of a NDHA should be taken into account and that a balanced judgement is required having regard to the scale of any harm or loss and the significance of the heritage asset.

Extensions to house

The Cotswold Design Code states that extensions should 'respect the scale, proportions ... and character of the building', and that 'modern extensions should not dominate or compete with the original building, either individually or cumulatively'.

The two-storey section of the extension closely reflects the scale and design of the extension previously permitted. This would form a significant addition to the existing host property; however, was considered on balance to in an acceptable increase in the scale of the property. The scheme previously permitted did not impact the front of the property and the evolution of the building remained clear. The dormer window to the side, whilst not similar to those on the front, was considered an acceptable feature. The overall form and materials were also considered in keeping with the existing character and appearance of the dwellinghouse. The previously approved scheme included a lean-to stone section which did not extend beyond the side of the frontage of the dwellinghouse. This was also considered to have an acceptable impact on the appearance of the dwellinghouse.

The addition of a timber single-storey section around the main stone section would result in additional bulk which is cumulatively considered harmful to the character and appearance of the dwellinghouse. The resulting extension proposed would be of a scale which would harm the modest compact character of the Northcote. The extensions would result in Northcote no longer being a clearly defined historic building that has been extended to accommodate

modern family life; it would appear as an amalgamation of large extensions fronted by a modest pair of historic cottages. The scale of the additions would result in more modern extension than historic core of the building.

The scheme which is proposed would more than double the footprint of the historic core of the host building. As such, it would not adhere to the guidance within the Cotswold Design Code which requires extensions to respect the scale of the building and avoid excessive bulk, either individually or cumulatively. In addition to the concerns expressed regarding the size, scale, and form of the proposed extensions, there are also concerns with elements of its design, in particular the north and south ends of the single-storey element, which extend beyond the building line of the original cottages, and which would therefore be visible from the front of the house.

These timber clad elements would not only appear incongruous, protruding out from behind Northcote's historic façade, emphasising the extent to which the building has been extended, they would also detract from the attractive composed nature the NDHA's front elevation.

Other design concerns include the overly scaled glazed screens and tall single-light windows on the single storey element, which appear inharmonious when viewed in the context of the more modest traditional fenestration that appears on the rest of the building. The use of extensive timber cladding in this context is also of concern.

Whilst the introduction of contemporary elements to an historic site may be acceptable in many contexts, the mix in this current scheme of both traditional and more contemporary elements lack cohesion and appear incompatible. They are considered not to accord with the principles of the Cotswold Design Code.

Outbuilding

The outbuilding would be relatively large and would be visible along the roads nearby. However, given the rural setting outside of the village, the semi-industrial/agricultural appearance of the proposed building, the size of the plot and the siting away from the main dwellinghouse, the building is considered not to harm the appearance of the site, nor setting of the NDHA.

The black cladding proposed for the elevations and roof would appear relatively stark, but this is considered to be acceptable given the visual separation between the outbuilding and dwelling, and the juxtaposition between old and new. This does, however, introduce an additional contemporary material, which would contrast with the use of timber on the proposed extensions.

The site is physically isolated from the main part of Cold Aston, as such, despite the proximity to the Cold Aston Conservation Area, the proposals are considered not to harm the setting of the conservation area.

Overall, the proposed new extensions to the dwellinghouse, by virtue of their scale, form and detailed design are considered to conflict with the design and heritage considerations of Local Plan Policies EN2 and EN12, and NPPF Section 12 and 16.

(b) Impact on Cotswolds Area of Outstanding Natural Beauty (AONB)

Section 85 of the Countryside and Rights of Way (CROW) Act 2000 states that relevant authorities have a statutory duty to conserve and enhance the natural beauty of the AONB.

Local Plan Policy EN4 states that development should take into account historic landscape character and local distinctiveness, and would be expected to enhance, restore or better manage significant historic landscape features, including key views, the setting of settlements, settlement pattern, and heritage assets. Local Plan Policy EN5 relates specifically to the Cotswolds AONB, and states that in determining development proposals within the AONB, or its setting, the conservation and enhancement of the natural beauty of the landscape, its character and special qualities will be given great weight. These are supported by NPPF Section 15, which seeks to conserve and enhance the natural environment.

The proposed developments are within the existing curtilage of the dwellinghouse. The single-storey wrap-around extension to the house includes a set of large glazed screens which allow direct access onto the agricultural land beyond. This would result in light spill which, it is considered, would impact upon the tranquillity of the landscape of the Cotswolds AONB, which is recognised for its characteristically dark skies. As this is the site boundary, it would be impractical to attempt to screen this, as any planting/fencing would be in the field to the rear. The extension itself, whilst not physically encroaching into the field behind, by virtue its positioning along the boundary, it would visually appear to encroach into this area. As such, the proposal is considered to harm the landscape and Cotswolds AONB.

The outbuilding is proposed to be located in the far northern corner of the site and whilst this would be visible in public views into the site, as it falls within the existing residential curtilage, it is considered not to harm the character or appearance of the protected landscape.

For the reasons outlined above, it is considered that the proposals would result in harm to the AONB and therefore fail to accord with Local Plan Policies EN4 and EN5, and Section 15 of the NPPF.

(c) Residential Amenity

Local Plan Policy EN2 refers to The Design Code (Appendix D) which sets out policy with regard to residential amenity. This expects proposals to respect amenity in regards to garden space, privacy, daylight and overbearing effect. Section 12 of the NPPF requires good design with a high standard of amenity for existing and future users.

The workshop/garage (The Villa Buildings) to the south has been granted permission to convert to a dwellinghouse. The main dwellinghouse of this converted building would be located approximately 31m from the side of the two-storey element of the extension which is a considerable distance. Given this, and the existing side windows of Northcote, it is considered the impact on the amenity of these future occupiers would not be harmed with regards to loss of light, privacy or by an overbearing effect.

The outbuilding is located away from any neighbouring properties. The site as a whole is considered to have sufficient garden space to accommodate the extensions and outbuilding without undue restriction of the amenity space.

The impact with regards to impact on residential amenity therefore remains acceptable, and it accords with the relevant considerations of Local Plan Policy EN2.

9. Conclusion:

The proposal is considered to harm the character and significance of the non-designated heritage asset, and would cause harm to the Cotswolds Area of Outstanding Natural Beauty (AONB), as such, it is contrary to Local Plan Policies EN2, EN4, EN5 and EN12.

10. Reasons for Refusal:

1. Northcote has been identified as a non-designated heritage asset following the criteria set out within Cotswold District Local Plan Policy EN12. The National Planning Policy Framework requires Local Planning Authorities to take into account the effect of an application on the significance of non-designated heritage assets and to come to a balanced judgement regarding the scale of any harm or loss and the significance of the heritage asset. The current proposals, by virtue of the addition of an overlarge extension of an unsympathetic design, would cause a level of harm disproportionate to the significance of this building as a non-designated heritage asset. As such the proposal conflicts with NPPF Section 16, specifically paragraph 197. The proposals are also contrary to Policies EN2 and EN12 of the Cotswold District Local Plan.

2. The site lies within the Cotswolds Area of Outstanding Natural Beauty (AONB), wherein the Local Planning Authority is statutorily required to have regard to the purpose of conserving and enhancing the natural beauty of the landscape. The proposed extensions would include a large glazed area directly on the boundary of the site with open fields, without the potential for screening. This would result in light spill which would negatively impact the tranquillity of the landscape of the Cotswolds AONB, which is recognised for its characteristically dark skies. It is considered that the proposals would fail to conserve or enhance the natural beauty of the AONB, contrary to Cotswold District Local Plan Policies EN2, EN4 and EN5 and NPPF Section 15, specifically paragraphs 170 and 172.

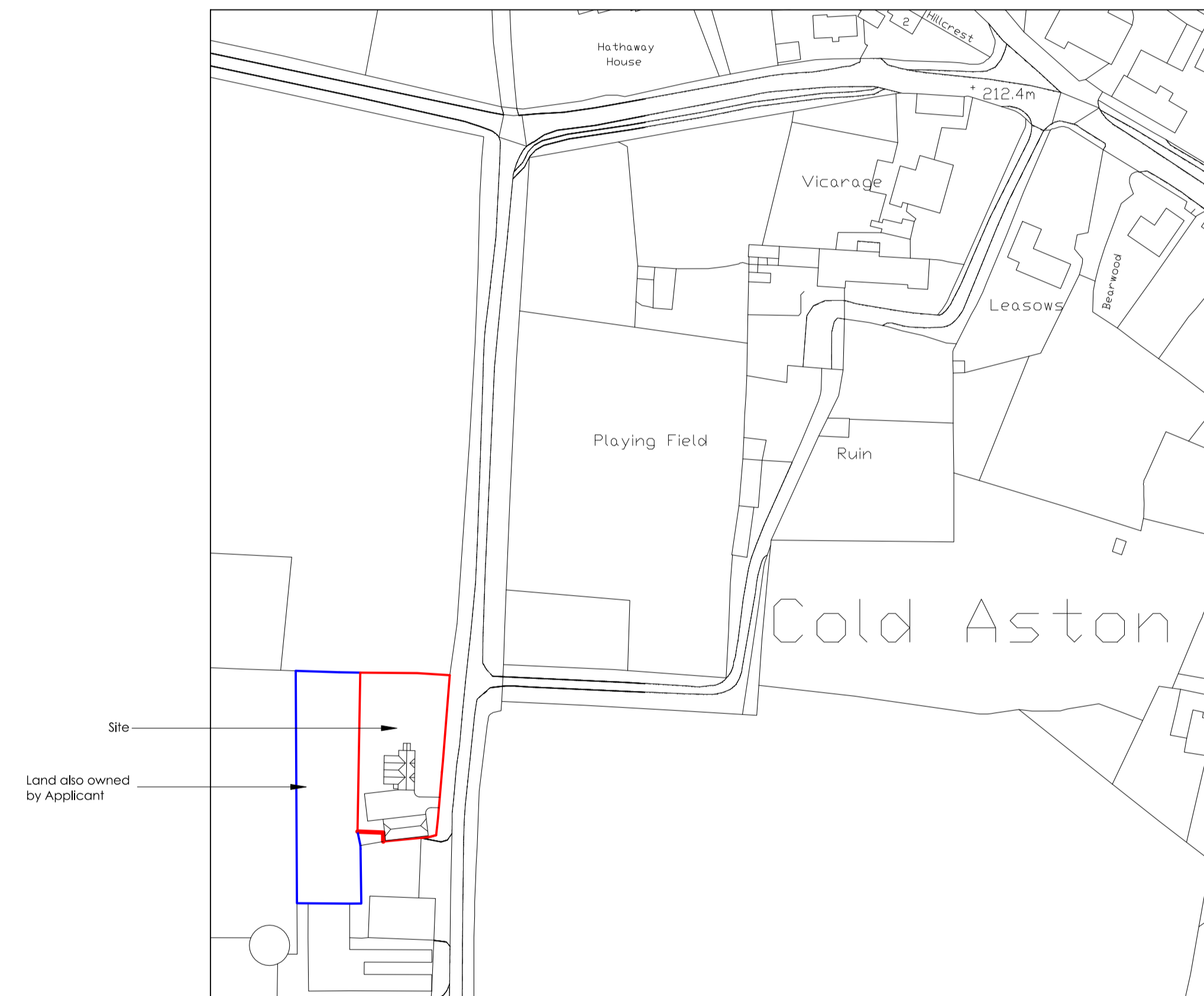

Location Plan
 scale 1:1250

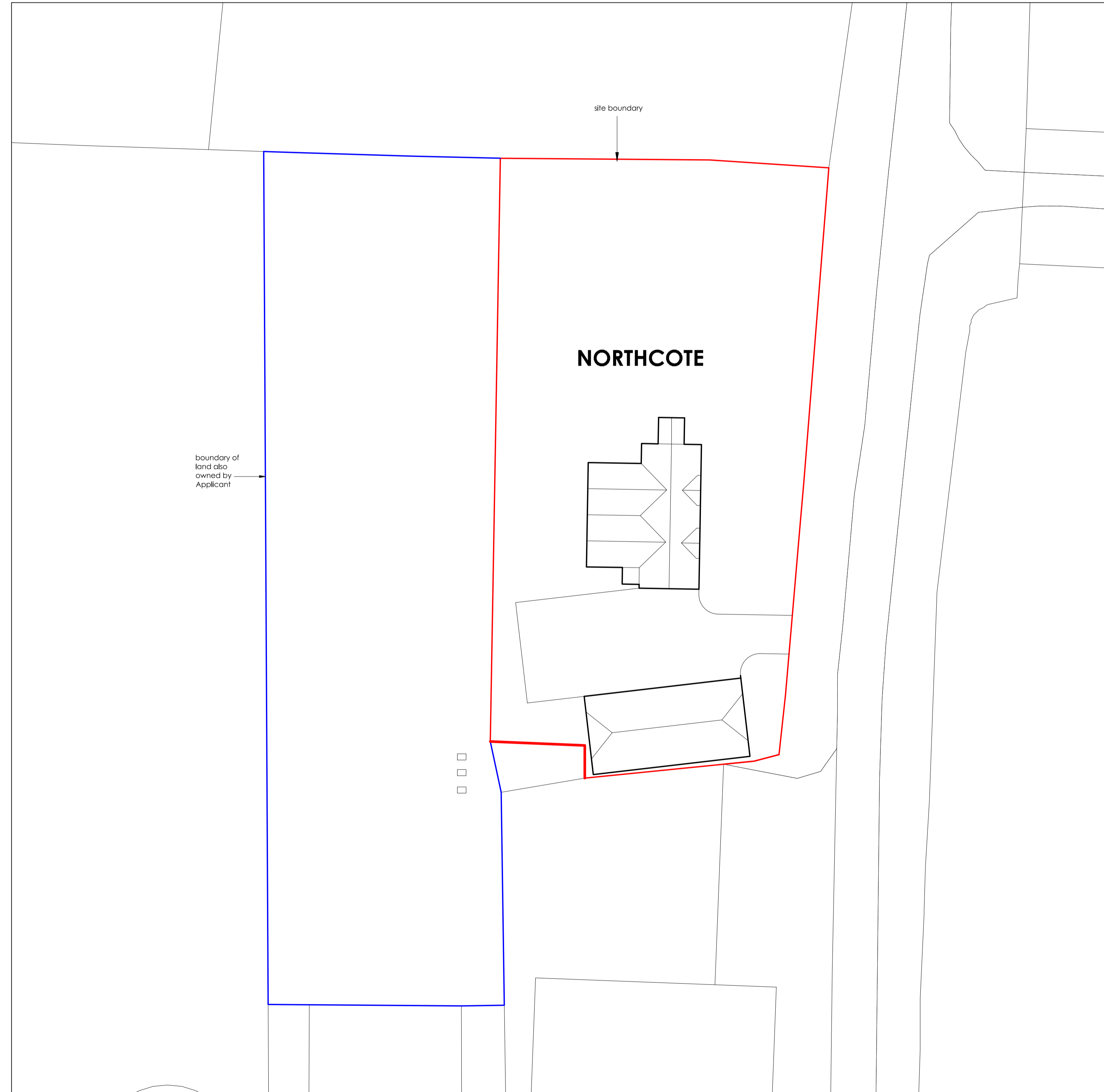

Existing Site Plan
 scale 1:200

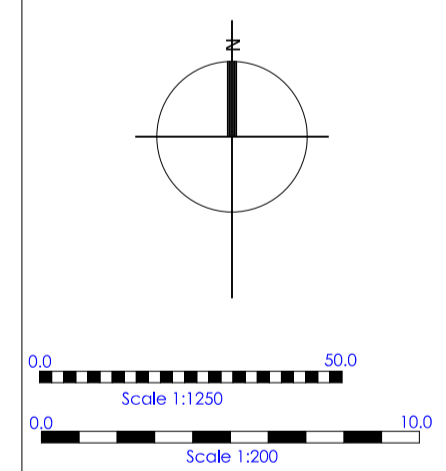

Status
PLANNING

Project
 Alterations and Additions
 Northcote
 Cold Aston

Client
 Mr and Mrs T
 Hayman-Joyce

Drawing
 Location Plan and Site
 Plan

Scale 1:200 / 1:250 @ A1 Date May 2020

EASTABROOK ARCHITECTS
 RIBA #
 Karl House
 Sheep Street
 Stratford-upon-Avon
 Gloucestershire G5 4 1HQ
 Phone: 01451 830541
 email: info@eastabrookarchitects.co.uk
 www.eastabrookarchitects.co.uk

Drawing Number 1282 / L100 Revision



North Elevation



West Elevation



East Elevation



South Elevation

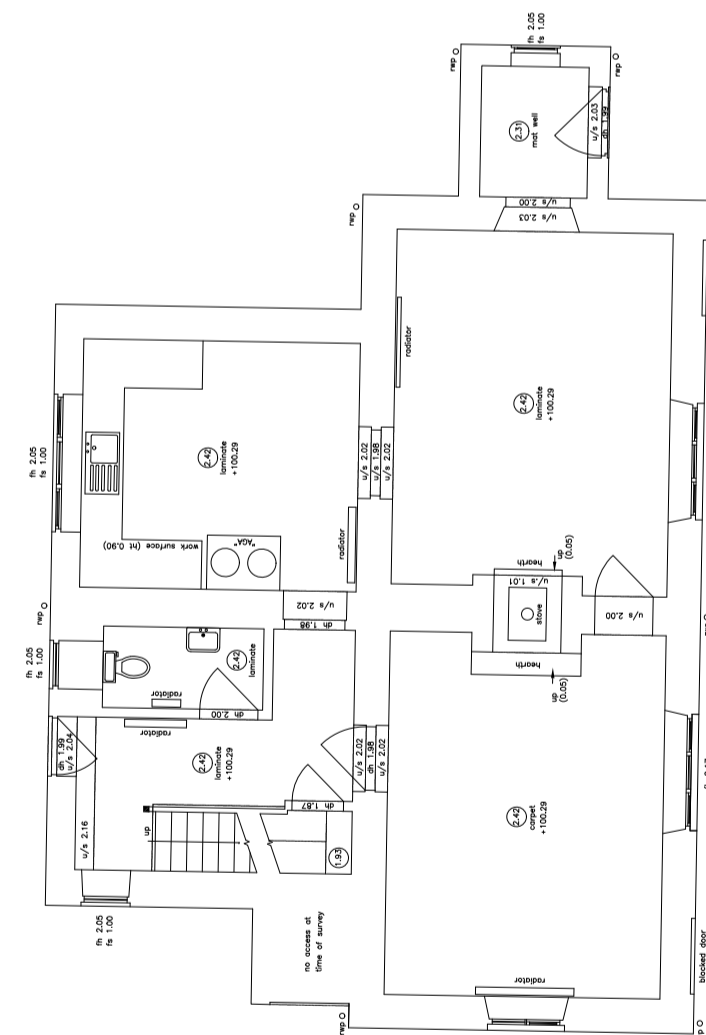

Existing Ground Floor Plan

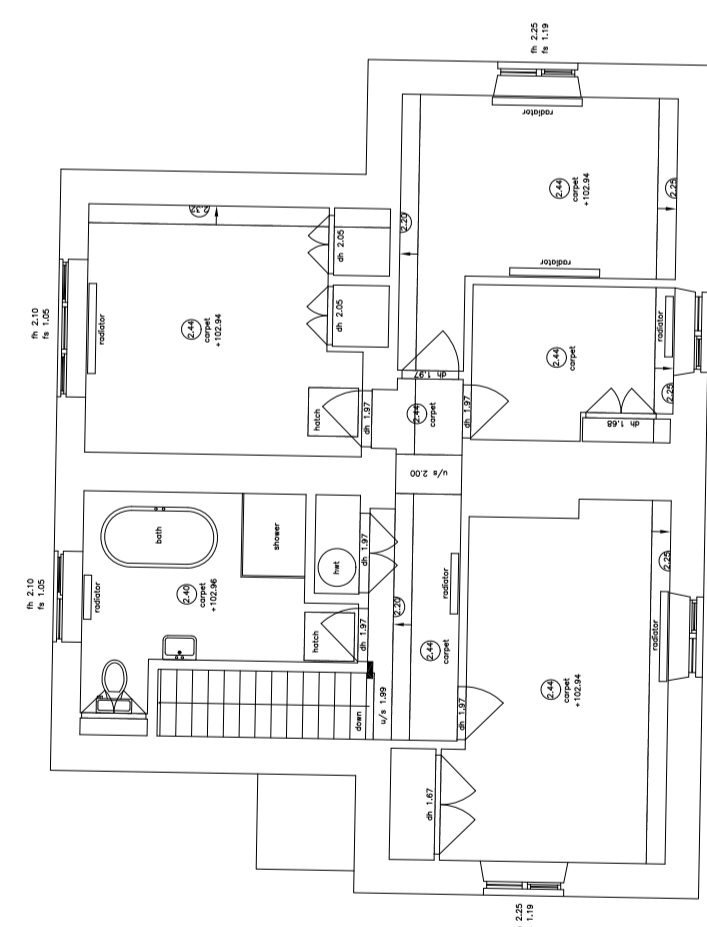

Existing First Floor Plan

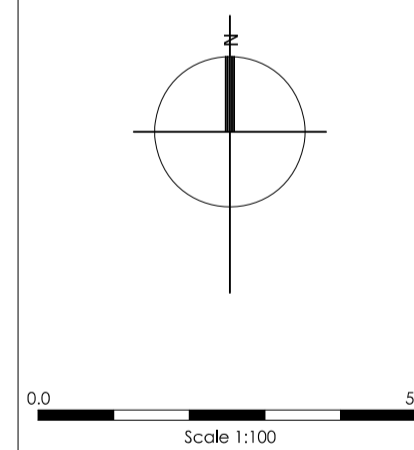

Status
PLANNING

Revisions

Project
Alterations and Additions
Northcote
Cold Aston

Client
Mr and Mrs T
Hayman-Joyce

Drawing
As Existing

Scale
1:100 @ A1

Date
May 2020

EASTBROOK ARCHITECTS
Kent House
Sheep Street
Stow-on-the-Wald
Gloucestershire GL54 1HQ
Phone: 01451 830541
enquiries@eastbrookarchitects.co.uk
www.eastbrookarchitects.co.uk

Drawing number
1282 / S100

Revision



North Elevation



West Elevation



East Elevation



South Elevation

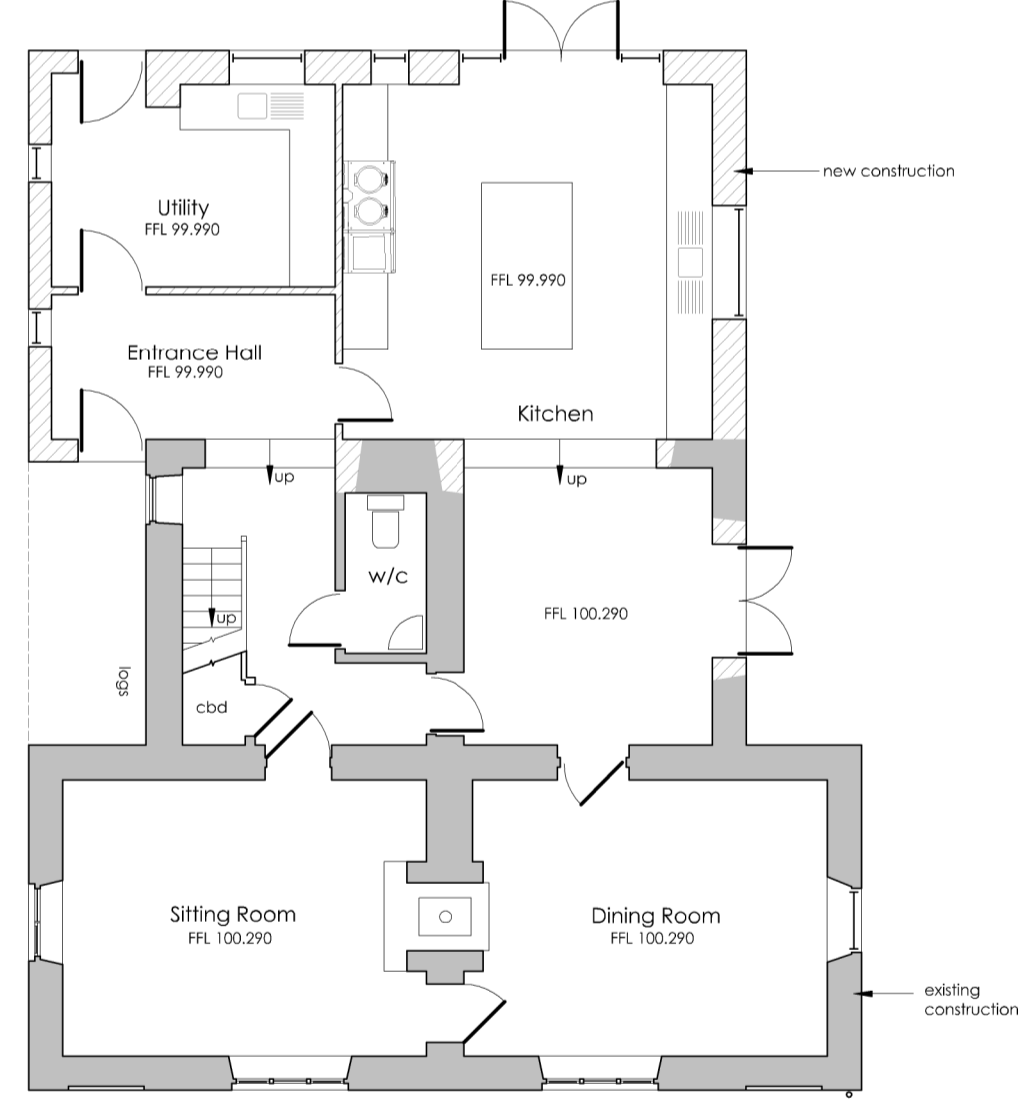

Ground Floor Plan

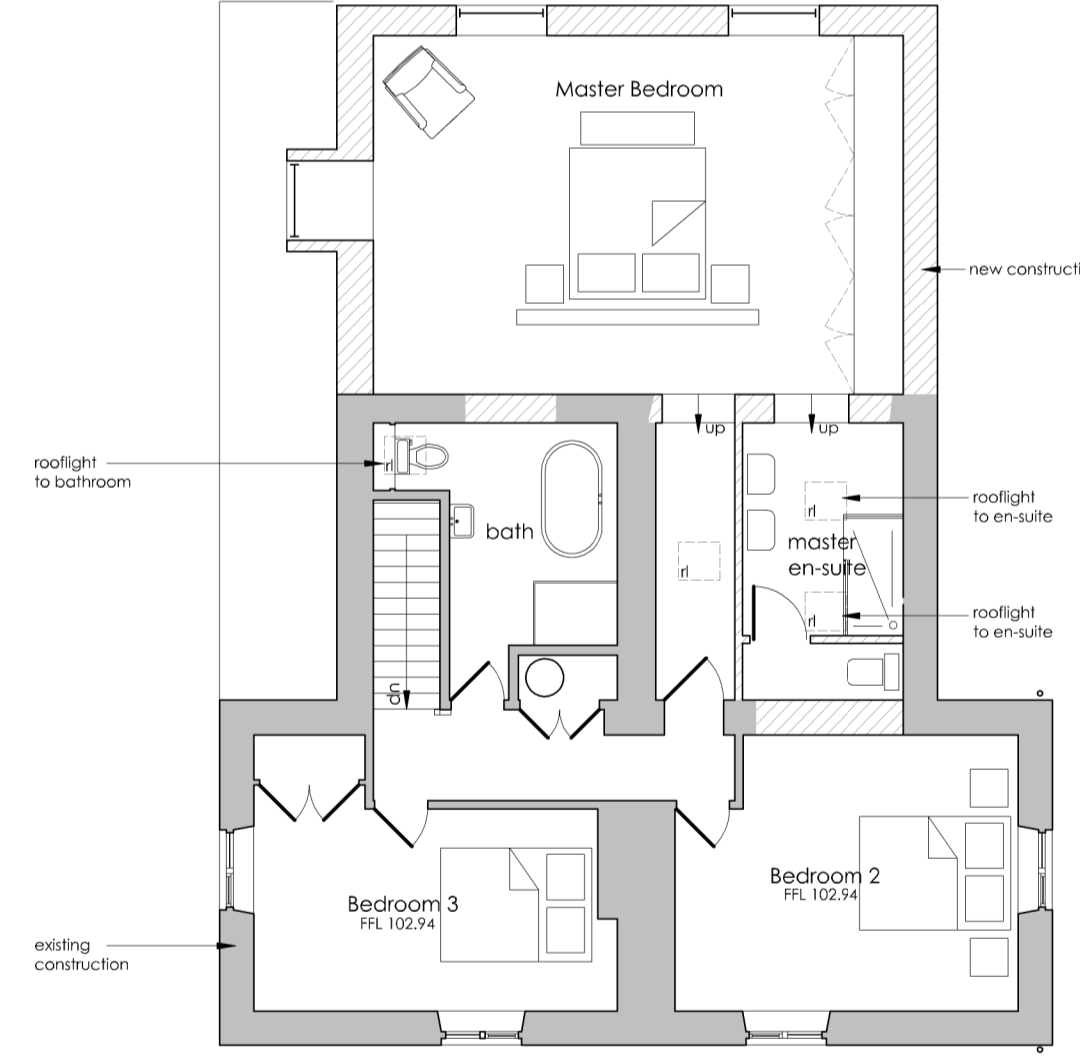

First Floor Plan

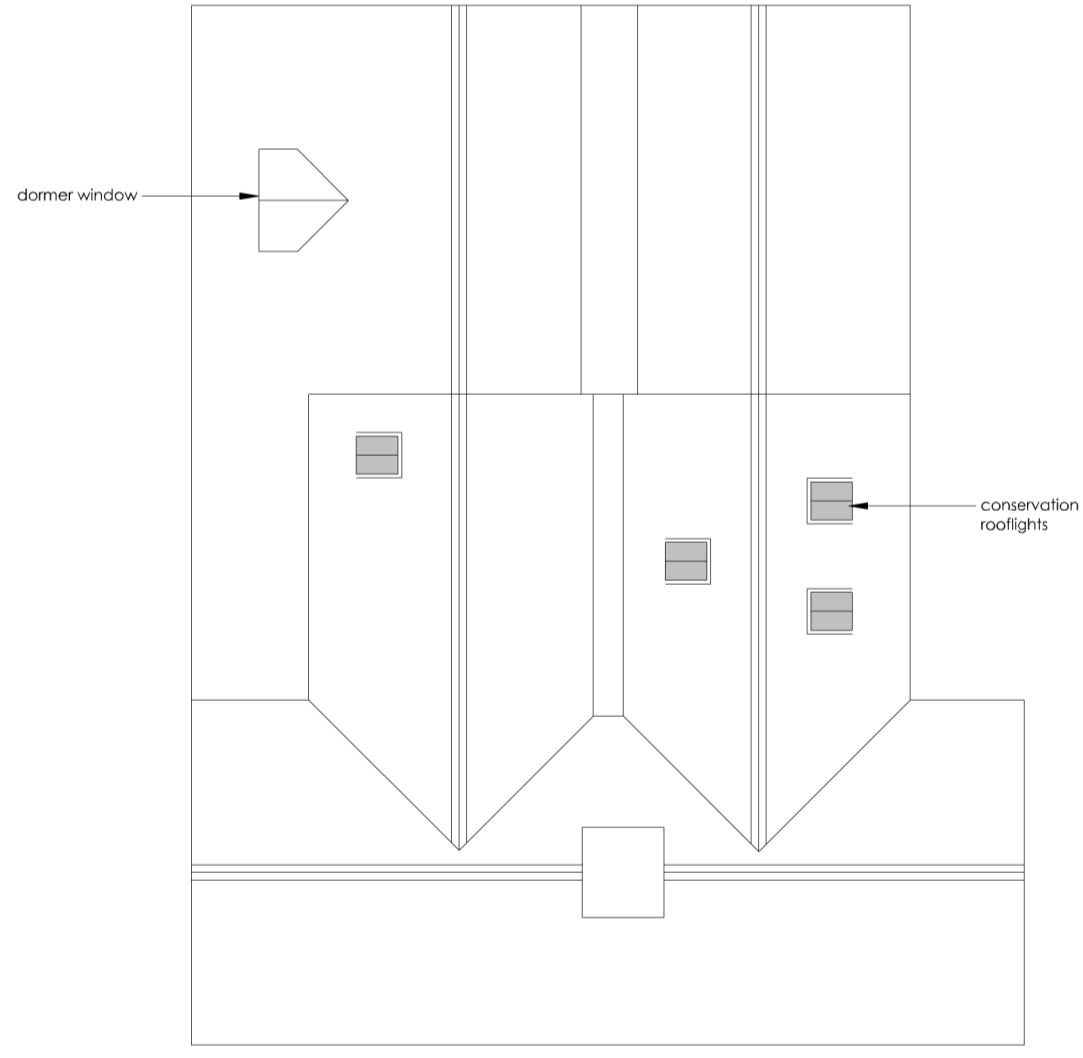

Roof Plan

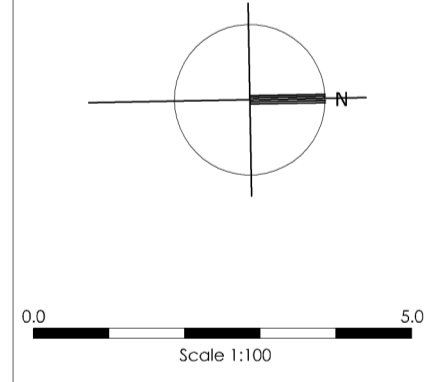

Status
PLANNING

Revisions
 A - 23.01.20 - material notes updated

Project
 Alterations and Additions
 Northcote
 Cold Aston

Client
 Mr and Mrs T
 Hayman-Joyce

Drawing
 Proposed House Alterations

Scale
 1:100 @ A1

Date
 December 2019

EASTABROOK ARCHITECTS
 Kent House
 Sheep Street
 Stroud-on-the-Wold
 Gloucestershire GL54 1HQ
 Phone: 01451 830541
 enquiries@eastabrookarchitects.co.uk
 www.eastabrookarchitects.co.uk

Drawing number
 1282 / P101

Revision
 A

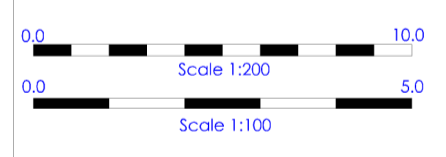
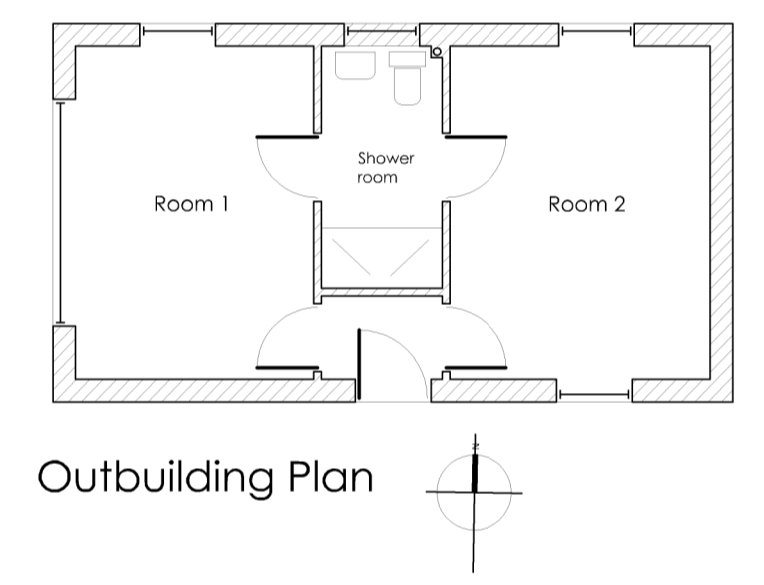

Status
PLANNING

Project
 Alterations and Additions
 Northcote
 Cold Aston

Client
 Mr and Mrs T
 Hayman-Joyce

Drawing
 Proposed Outbuilding
 and Site Plan

Scale
 1:100/200 @ A1

Date
 December 2019

EASTABROOK ARCHITECTS
 Kent House
 Sheep Street
 Stroud-on-the-Wold
 Gloucestershire GL54 1HQ
 Phone: 01451 830541
 enquiries@eastabrookarchitects.co.uk
 www.eastabrookarchitects.co.uk

Drawing number
 1282 / P101

Revision



North Elevation



West Elevation



East Elevation



South Elevation



Ground Floor Plan

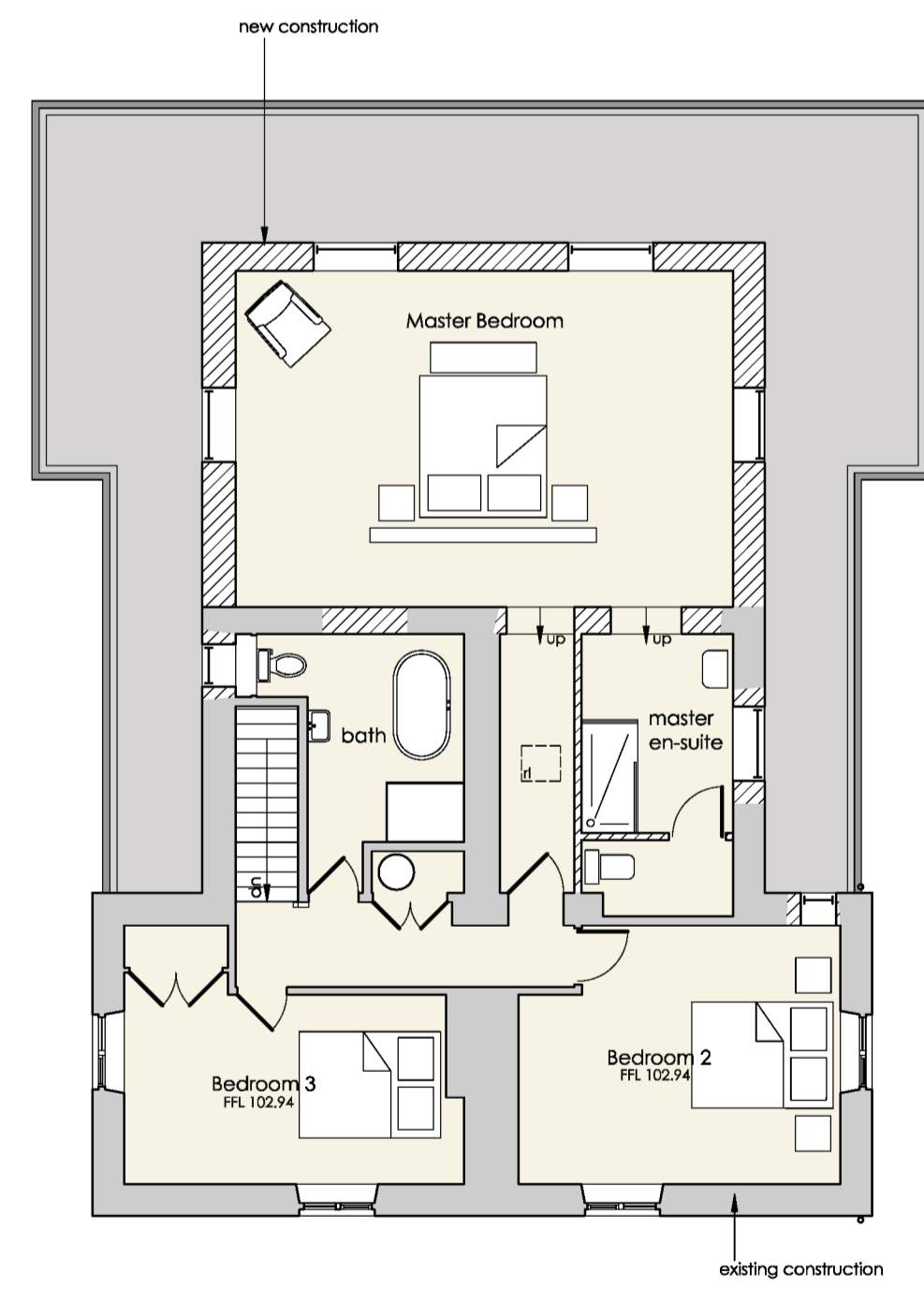

First Floor Plan

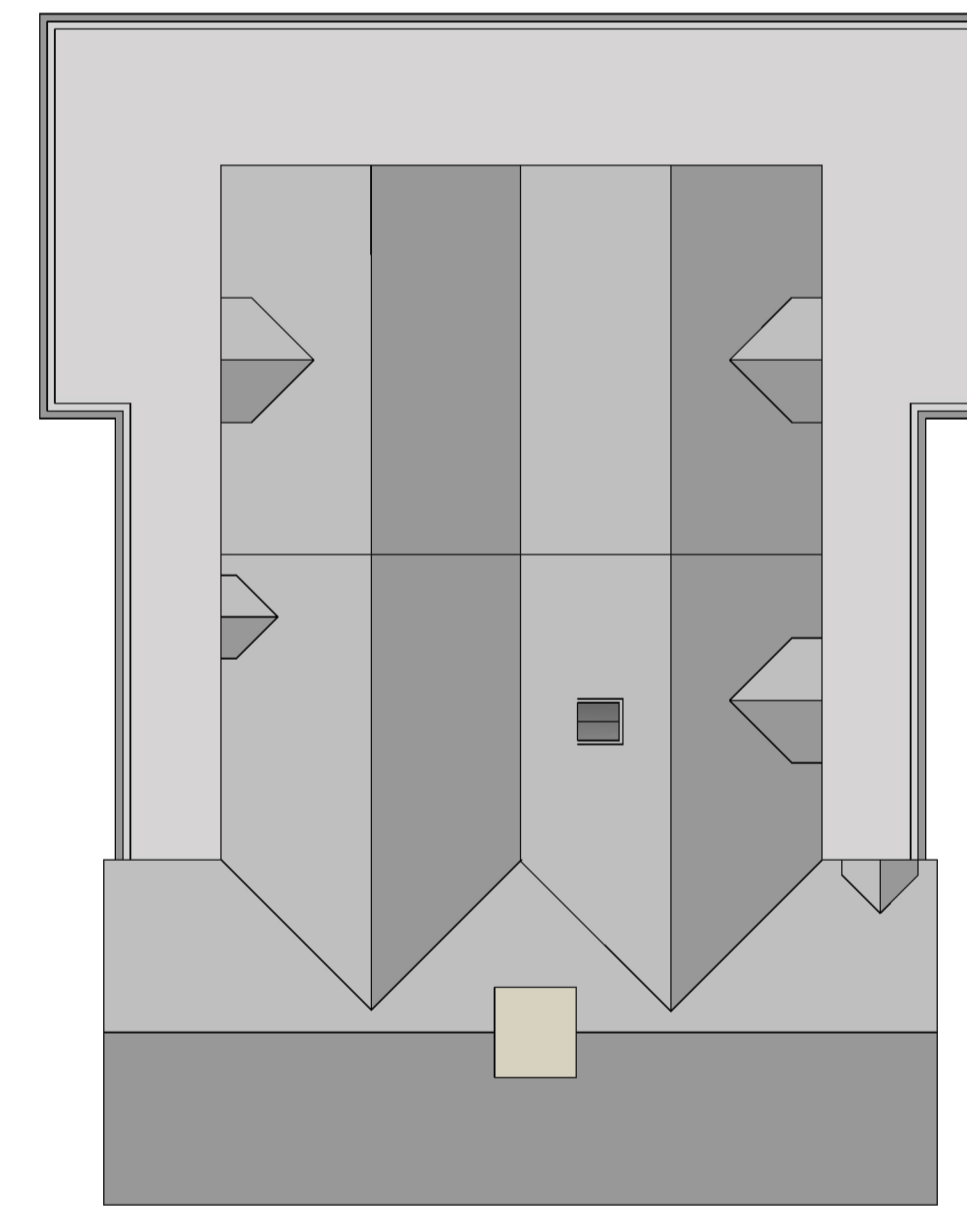

Roof Plan

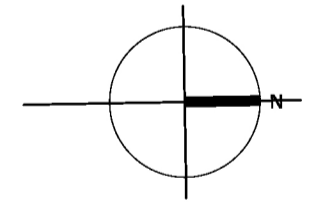

0.0 5.0
 Scale 1:100

Status PLANNING	
Revisions	
Project Alterations and Additions Northcote Cold Aston	
Client Mr and Mrs T Hayman-Joyce	
Drawing Proposed	
Scale 1:100 @ A1	Date May 2020
EASTABROOK ARCHITECTS <small>Kent House Sinsap Street Stonehouse, Wold Gloucestershire GL54 1HQ Phone: 01451 830541 enquiries@eastabrookarchitects.co.uk www.eastabrookarchitects.co.uk</small>	
Drawing number 1282 / P200	Revision

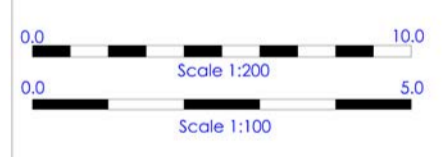
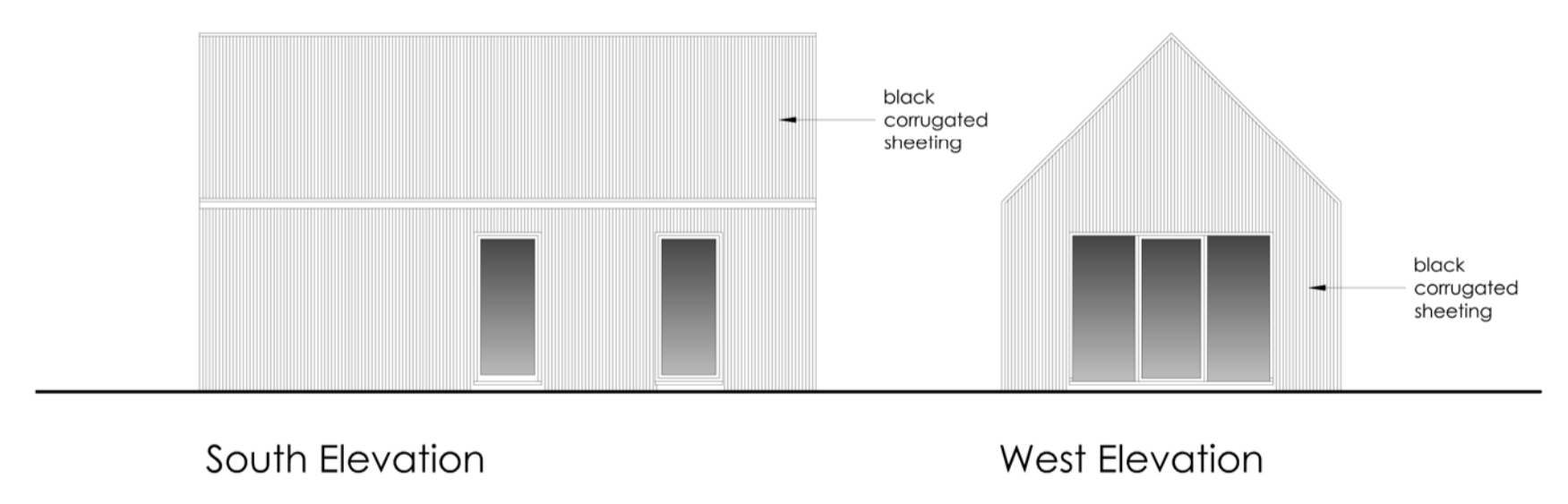
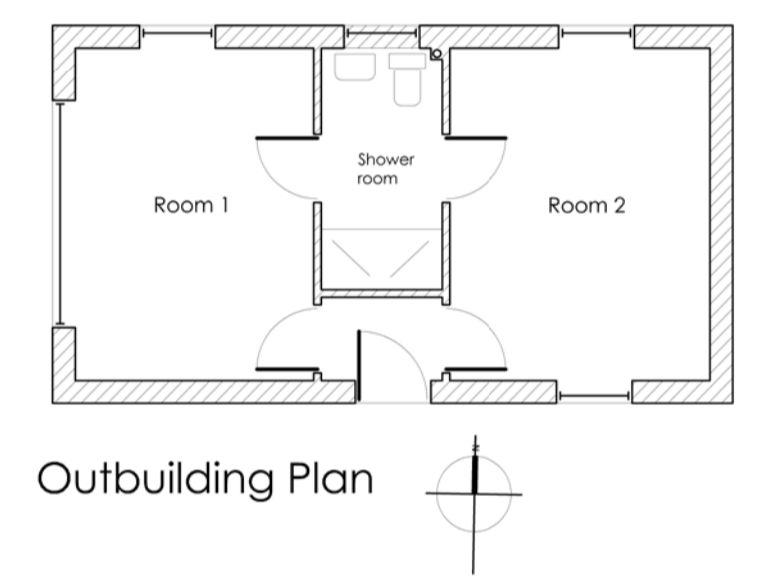
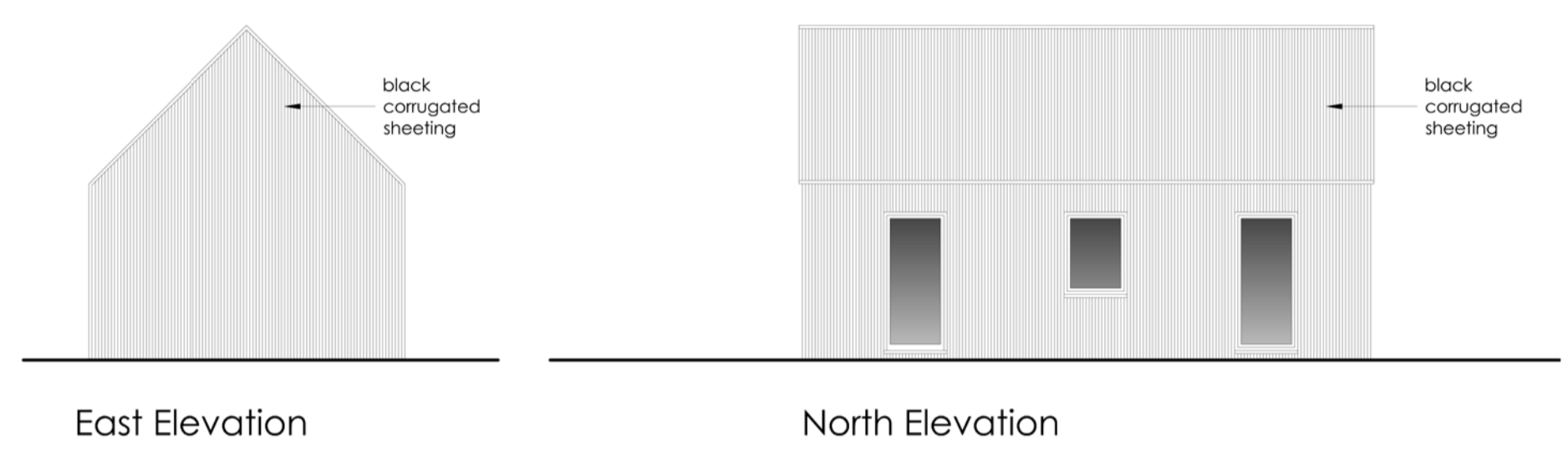

Status
PLANNING

Project
 Alterations and Additions
 Northcote
 Cold Aston

Client
 Mr and Mrs T
 Hayman-Joyce

Drawing
 Proposed Outbuilding
 and Site Plan

Scale
 1:100/200 @ A1

Date
 May 2020

EASTABROOK ARCHITECTS
 Kent House
 Sheep Street
 Stroud-on-the-Wold
 Gloucestershire GL54 1HQ
 Phone: 01451 830541
 enquiries@eastabrookarchitects.co.uk
 www.eastabrookarchitects.co.uk

Drawing number
 1282 / P201

Revision